

MELAMINICO

Hmin= 1108 mm Hmax= 1118 mm

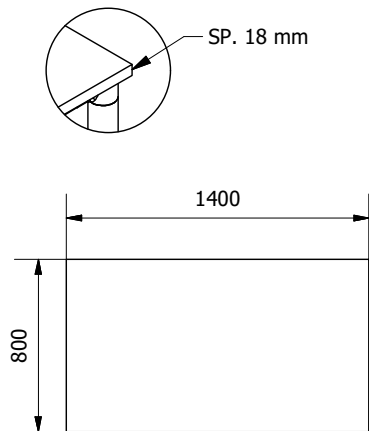
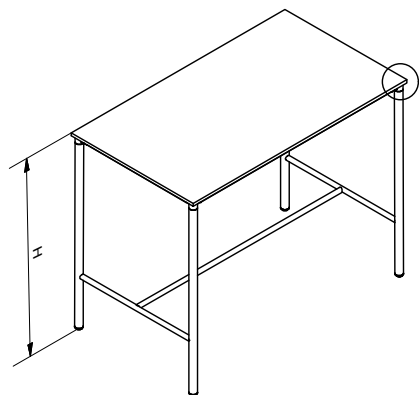

STRAFICATO

Hmin= 1100 mm Hmax= 1110 mm

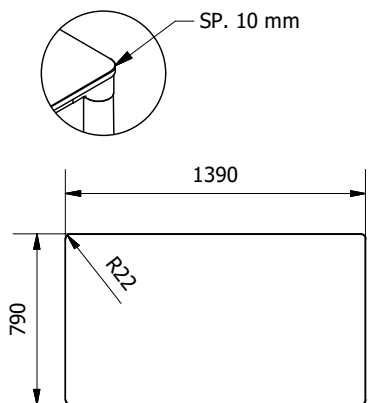
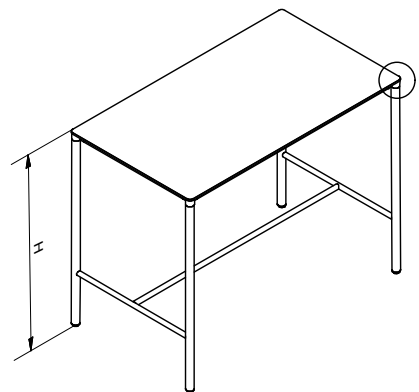

CRISTALLO/SUPERCERAMICA/SUPERMARMO

	CRISTALLO	SUPER-CER.	SUPER-MAR.
Hmin	1103	1102	1106
Hmax	1113	1112	1116

SP. CRISTALLO 10 mm
 SP. SUPERCERAMICA 9 mm
 SP. SUPERMARMO 13 mm

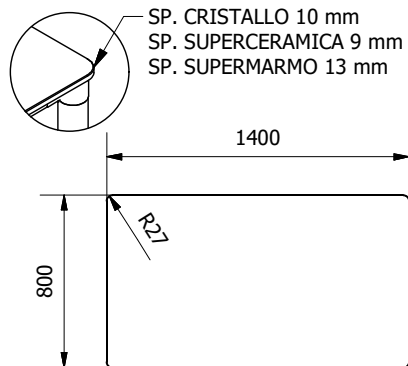

MODELLO: MOON ALTO

N.DIS.: T201_301_53.21

DISEGNATORE:Montesi F.

ARTICOLO: 53.21

DATA:23/02/2021

APPROVATO UFF.TECNICO

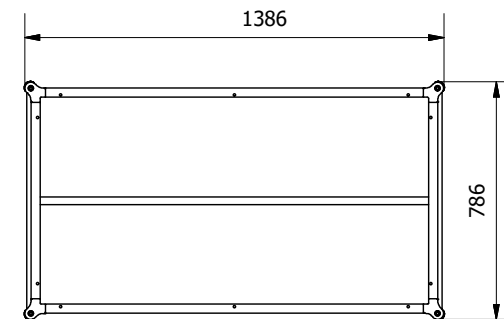
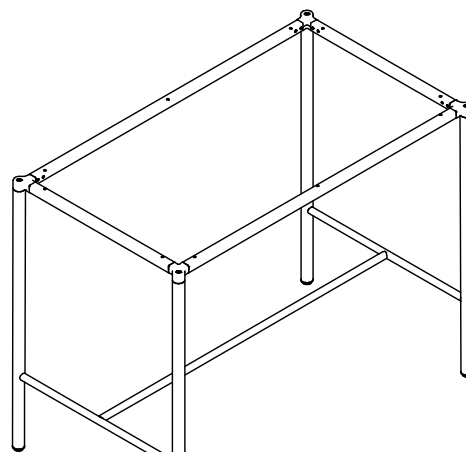
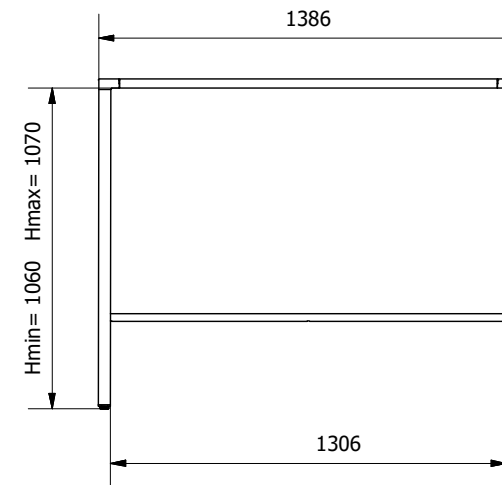
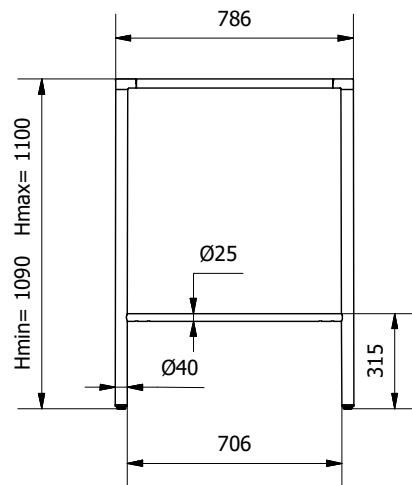

PIEDINO REGOLABILE

