

**STRAFICATO**

Hmin= 1100 mm Hmax= 1110 mm

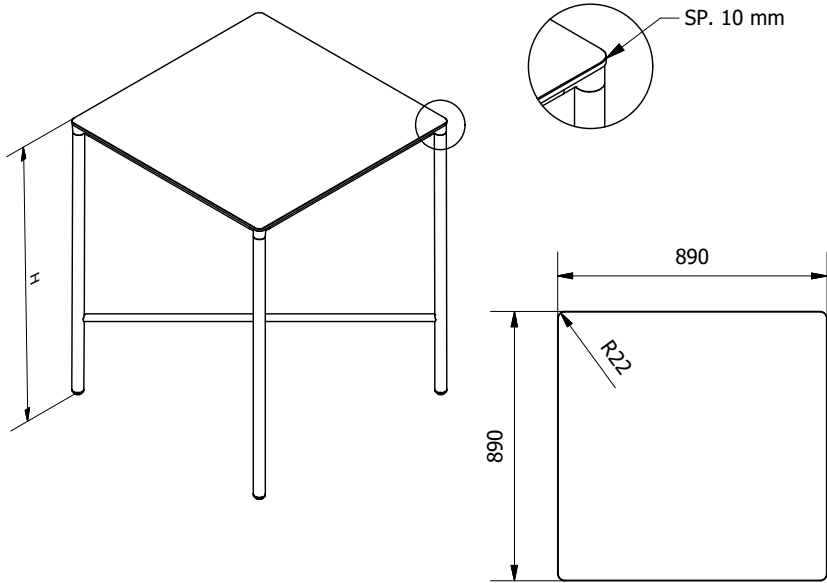

MODELLO: MOON ALTO

N.DIS.: T201\_303\_53.19OUT DISEGNATORE:Montesi F.

ARTICOLO: 53.19OUT

DATA:23/02/2021

APPROVATO UFF.TECNICO

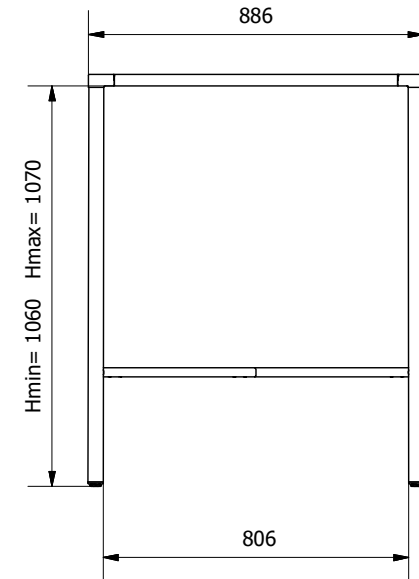
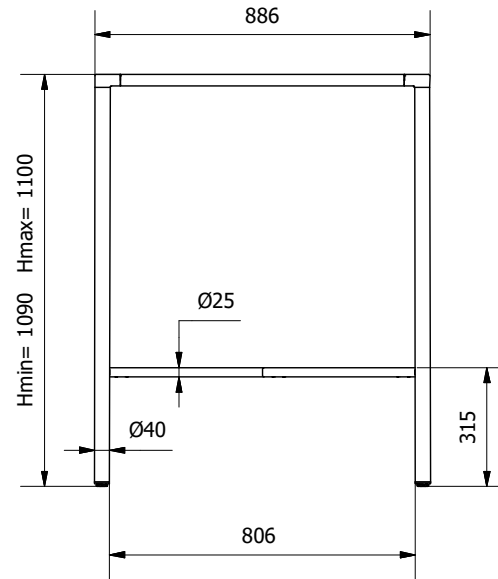

**CRISTALLO/SUPERCERAMICA/SUPERMARMO**

	CRISTALLO	SUPER-CER.	SUPER-MAR.
Hmin	1103	1102	1106
Hmax	1113	1112	1116

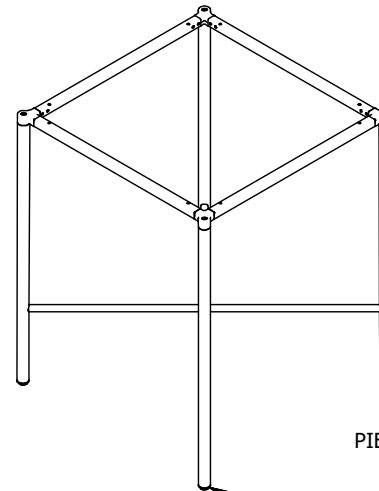
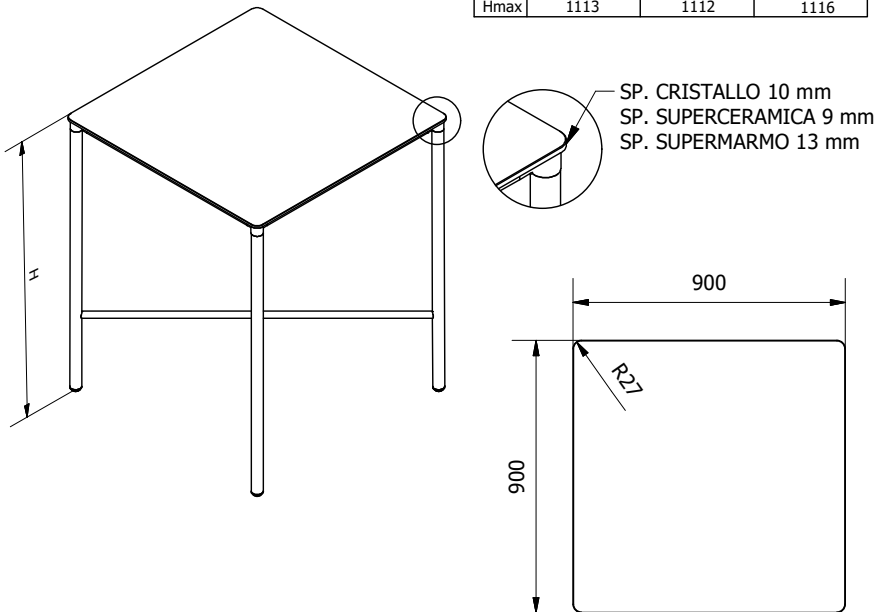

PIEDINO REGOLABILE

