

MELAMINICO

Hmin= 1108 mm Hmax= 1118 mm

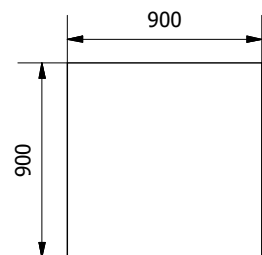
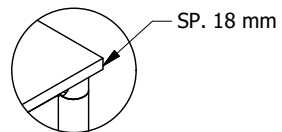
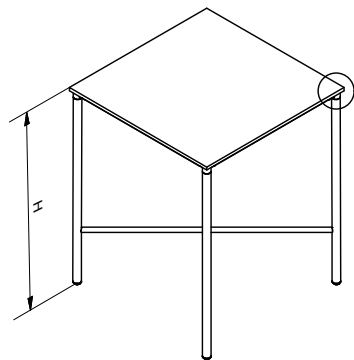

STRAFICATO

Hmin= 1100 mm Hmax= 1110 mm

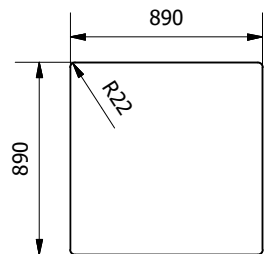
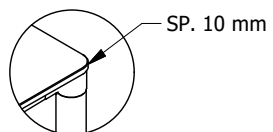
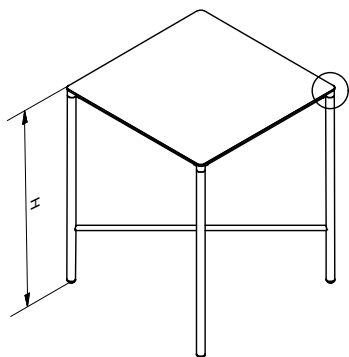

CRISTALLO/SUPERCERAMICA/SUPERMARMO

	CRISTALLO	SUPER-CER.	SUPER-MAR.
Hmin	1103	1102	1106
Hmax	1113	1112	1116

SP. CRISTALLO 10 mm
 SP. SUPERCERAMICA 9 mm
 SP. SUPERMARMO 13 mm

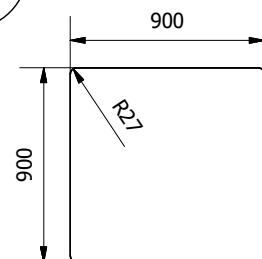
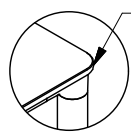
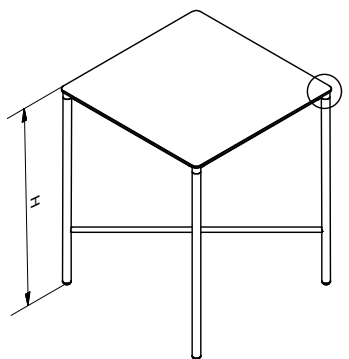

MODELLO: MOON ALTO

N.DIS.: T201_303_53.19

DISEGNATORE:Montesi F.

ARTICOLO: 53.19

DATA:23/02/2021

APPROVATO UFF.TECNICO

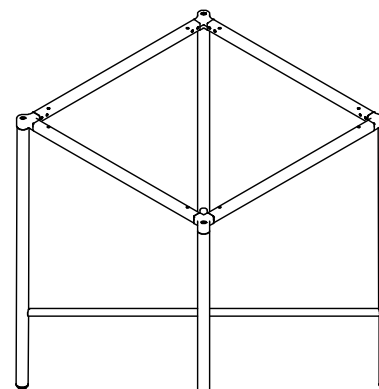
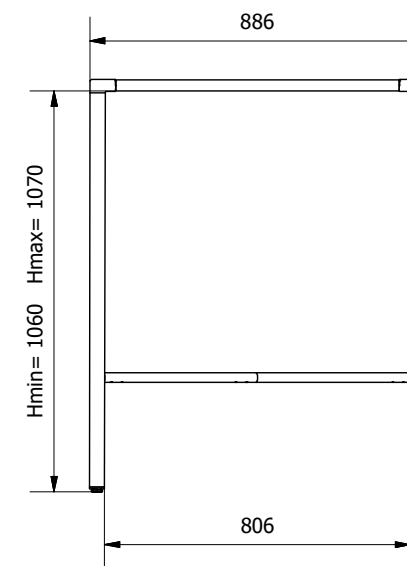
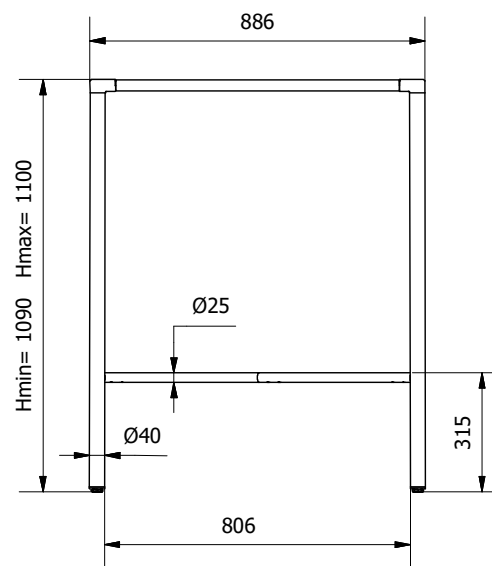

PIEDINO REGOLABILE

