

STRAFICATO

Hmin= 1108 mm Hmax= 1118 mm

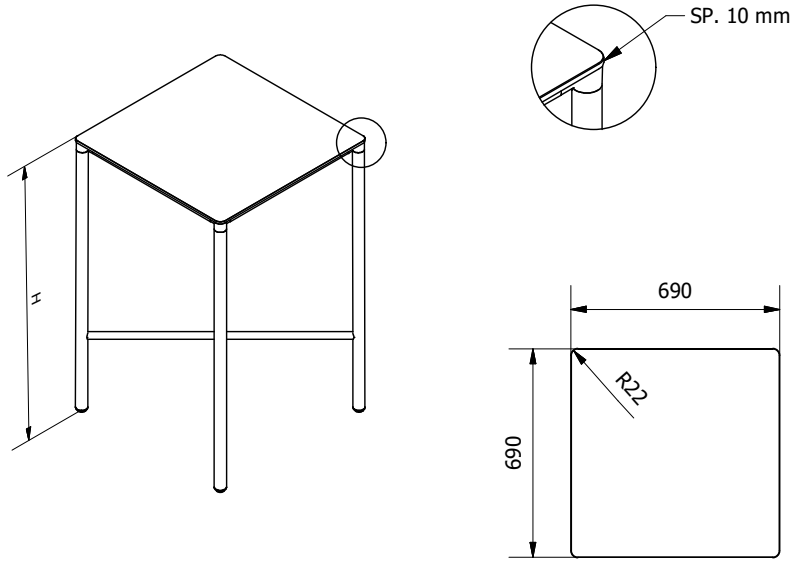

MODELLO: MOON ALTO

N.DIS.: T201_305_53.1700 DISEGNATORE:Montesi F.

ARTICOLO: 53.170UT

DATA:23/02/2021

APPROVATO UFF.TECNICO

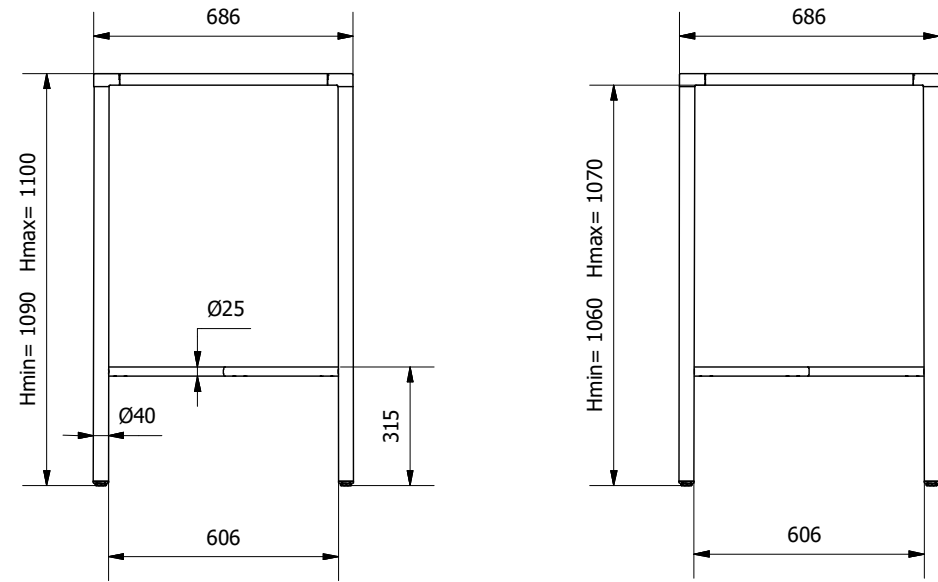

CRISTALLO/SUPERCERAMICA/SUPERMARMO

	CRISTALLO	SUPER-CER.	SUPER-MAR.
Hmin	1103	1102	1106
Hmax	1113	1112	1116

