

STRAFICATO

Hmin= 750 mm Hmax= 760 mm

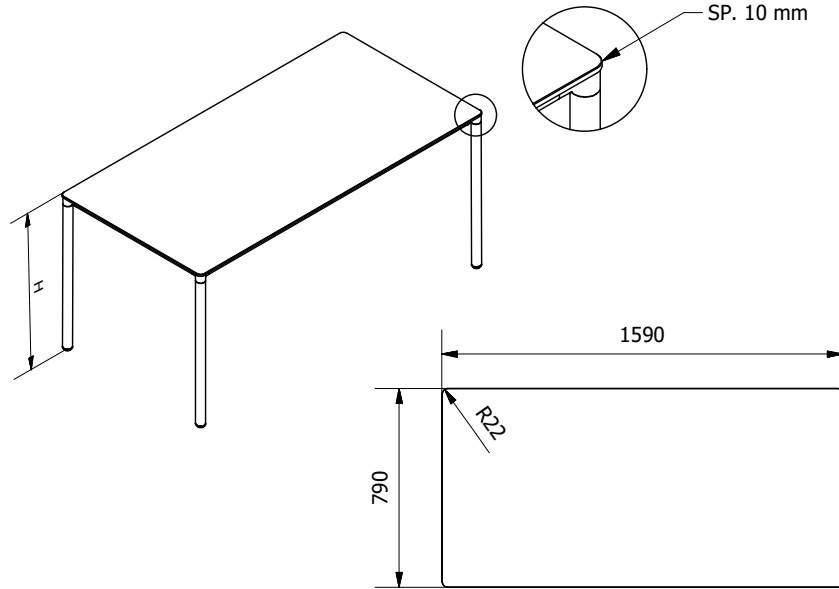

MODELLO: MOON

N.DIS.: T201_306_53.14OUT DISEGNATORE:Montesi F.

ARTICOLO: 53.14OUT

DATA:23/02/2021

APPROVATO UFF.TECNICO

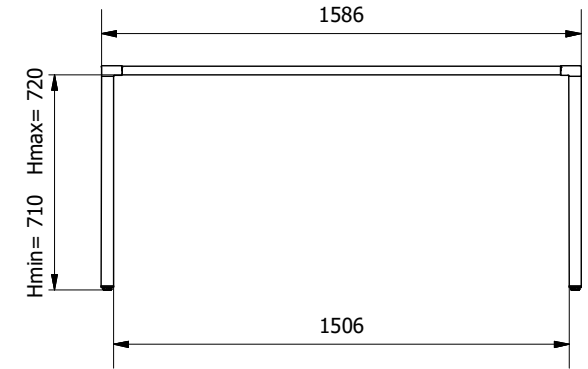
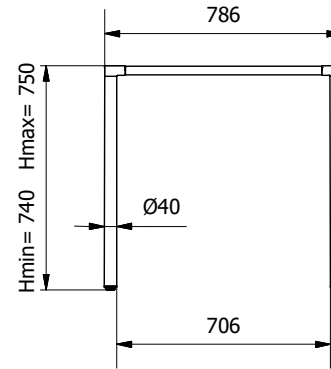

CRISTALLO/SUPERCERAMICA/SUPERMARMO

	CRISTALLO	SUPER-CER.	SUPER-MAR.
Hmin	753	752	756
Hmax	763	762	766

